







ST 060 113 2985



- cover plate 120 x 120 mm
- rosette 60 x 60 mm
- temperature control handle with safety limit stop at 38°C
- thermostat cartridge
- 2x head part with cut-to-length spindle and sleeve

	Brushed Chrome	ST 060 113 2985-93
	Chrome	ST 060 113 2985-00
	Brushed Platinum	ST 060 113 2985-06
	Platinum	ST 060 113 2985-08
	Brushed Light Gold	ST 060 113 2985-27
	Brushed Durabronze (23kt Gold)	ST 060 113 2985-28
	Brushed Dark Platinum	ST 060 113 2985-99

Individual components of this set

You need the following components for this set

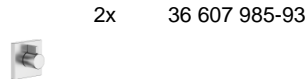
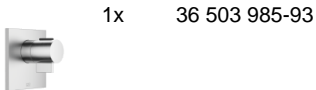



SYMETRICS xTOOL Thermostat module - Brushed Chrome

IMO











ST 060 113 2985

ST 060 113 2985



- cover plate 120 x 120 mm
- temperature control handle with safety limit stop at 38°C
- thermostat cartridge

Fits: IMO, MEM, CL.1, CYO

	Brushed Chrome	36 503 985-93
	Chrome	36 503 985-00
	Brushed Platinum	36 503 985-06
	Platinum	36 503 985-08
	Dark Chrome	36 503 985-19
	Brushed Light Gold	36 503 985-27
	Brushed Durabross (23kt Gold)	36 503 985-28
	Matte Black	36 503 985-33
	Brushed Champagne (22kt Gold)	36 503 985-46
	Champagne (22kt Gold)	36 503 985-47
	Brushed Dark Platinum	36 503 985-99

Required miscellaneous



xTOOL Concealed thermostat module without volume control - 35 503 970 90
 •max. recess depth 160 mm
 •min. recess depth 95 mm

Recommended miscellaneous



xGRID Attachment set for integrating in the dry wall construction - 12 340 970 90

Required miscellaneous



xGRID Installation track 555 mm - 12 360 970 90

ST 060 113 2985

mm [inches]

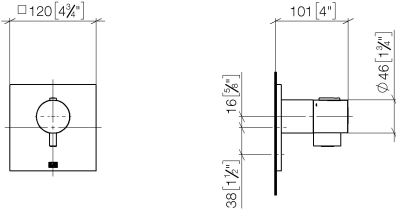

Flow rate chart

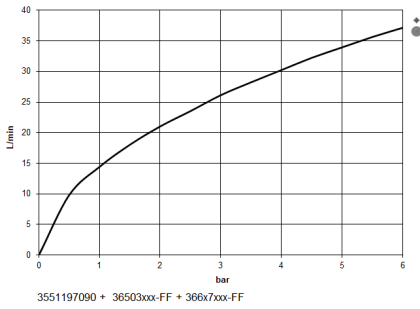

Certificates

WRAS_2011026. DVGW_DW-6512DN0706. LGA_29930. LGA_29932.

ST 060 113 2985

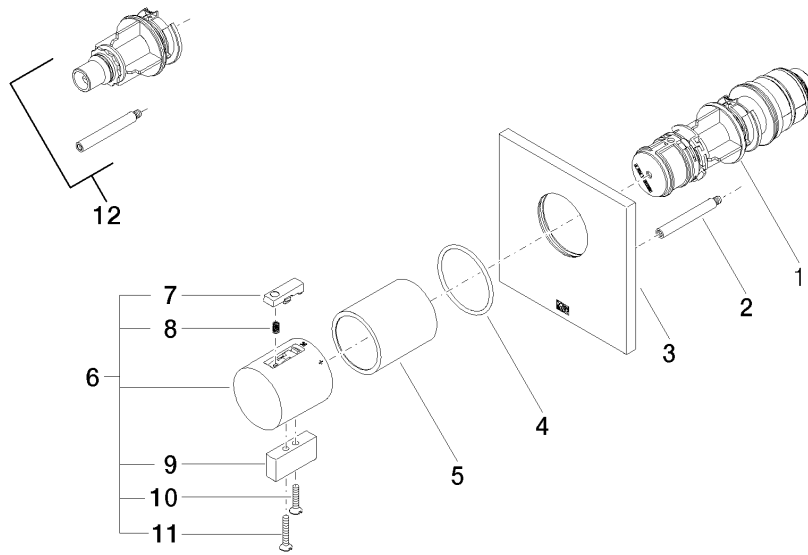







Spare parts list

No.	Item Number	Name	Quantity used	Delivery time
1	90 15 02 063 00 90	cartridge	1	2
2	90 31 09 095 00 90	bar	1	2
3	09 11 02 196-93	cover	1	60
4	90 14 10 049 00 90	seal	1	2
5	90 21 02 112 00-93	sleeve	1	-
Spare part can no longer be ordered, please order the replacement item				
6	04 17 33 006 00-93	handle	1	60
7	90 21 33 011 00-13	handle	1	2
8	90 16 02 027 00 90	spring	1	2
9	09 20 33 006-93	handle	1	20
10	09 30 30 159-93	screw	1	20
11	09 30 30 160-93	screw	1	20
12	12 178 970 90	Extension 46 mm -	1	2

ST 060 113 2985



- rosette 60 x 60 mm
- head part with cut-to-length spindle and sleeve

	Brushed Chrome	36 607 985-93
	Chrome	36 607 985-00
	Brushed Platinum	36 607 985-06
	Platinum	36 607 985-08
	Brushed Light Gold	36 607 985-27
	Brushed Durabass (23kt Gold)	36 607 985-28
	Brushed Dark Platinum	36 607 985-99



SYMETRICS xTOOL Thermostat module - Brushed Chrome

IMO

ST 060 113 2985

ST 060 113 2985

mm [inches]

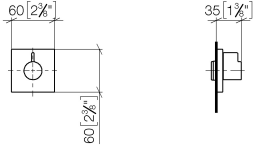

Certificates

DVGW_DW-
6501DN0116.

WRAS_2011026.

IAPMO_4976 (2).

LGA_29931.

WRAS_2010066.

DVGW_DW-
6512DN0706.

LGA_29932.

ST 060 113 2985

Parts for other finishes can be found here: [Chrome](#)

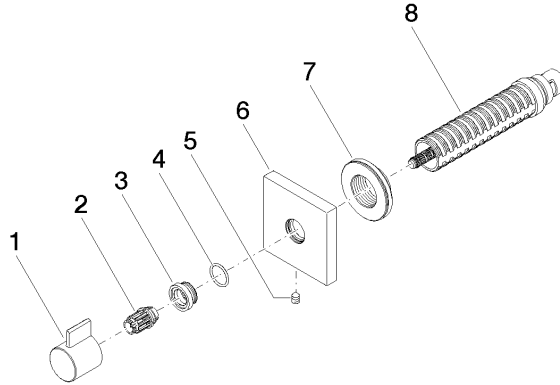

Spare parts list

No.	Item Number	Name	Quantity used	Delivery time
1	09 20 98 002-93	handle	1	20
2	09 12 12 005 90	fixing cap	1	2
3	09 12 12 043-93	base	1	20
4	09 14 10 017 90	seal	1	2
5	90 31 11 004 00 90	pin	1	2
6	09 27 98 014-93	rosette	1	20
7	09 21 02 151 90	sleeve	1	2
8	90 90 03 202 00 90	top	1	2